

## Zenport QF2 8.5 inch Classic Professional Pruner

Pruning shear - High performance - Ergonomic - Industry Standard Architecture



25mm/1in.



S L



215mm/8.5in.



240g/8.5oz.

- **Reliable:** comfortable, light, sturdy handles made of forged aluminium / blade and riveted anvil blade made of high-quality hardened steel / clean, precise cut / all parts can be replaced
- **Efficient:** easy, durable cutting adjustment / wire cutting notch / sap groove
- **Ergonomic:** hand protection is provided by the cushion-shock absorber / non-slip coating

Our recommendation (1★: Recommended, 2★: Strongly recommended, 3★: Best fit)

Viticulture	★★★
Arboriculture	★★★
Horticulture	★★★
Parks and Gardens	★★★
Nursery	★★★
Small hand	★★★
Large hand	★★★
Left-handed	★★★

---

## The points of excellence



### Forged aluminium handles

Lightweight, strong and sturdy thanks to special aluminium alloys and advanced precision forging methods perfectly mastered by Zenport Industries.

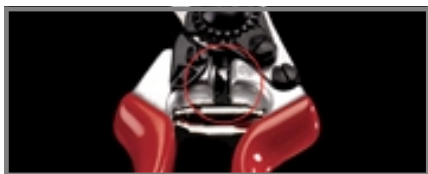

### Shock absorption system

Zenport's special cushion stops reduce impact at the end of a cut, protecting hand and wrist.

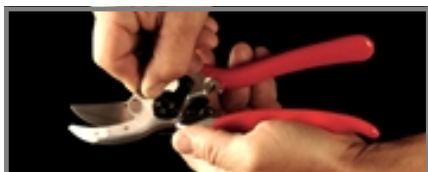

### Precision adjustment system

Zenport's micrometric adjustment system guarantees an optimal adjustment of the cutting head throughout the life of the tool, and delivers a clean and precise cut every time.



### Sap groove

The sap groove prevents the blade sticking when cutting "sappy" wood. It saves time and makes pruning easier by removing sap and debris after each cut.











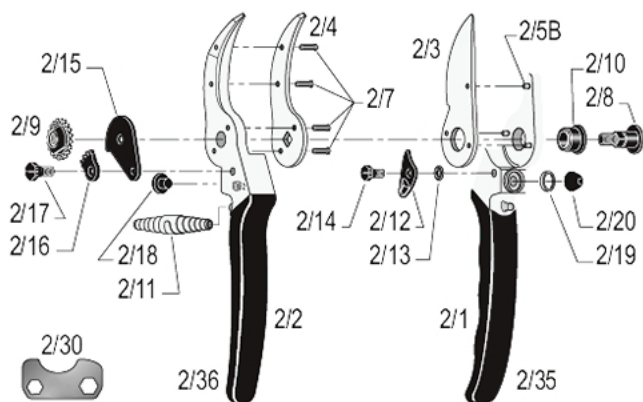

### Wire cutting notch

















The blades of most QF Series pruning shears feature a notch that allows for the cutting of small wires without damaging the cutting edge.

---

## Spare parts



	REF.	Designation	Composition
	2/30	Adjustment key	1x QF2/30
	2/3	Blade	1x QF2/3
	2/4	Anvil-blade with rivets	1x QF2/4 + 4x QF2/7
	2/90	Kit	1x QF2/17 + 1x QF2/16 + 1x QF2/9 + 1x QF2/8
	2/91	Kit	2x QF2/11
	2/92	Kit	1x QF2/15 + 1x QF2/18 + 1x QF2/14 + 1x QF2/12 + 1x QF2/13 + 1x QF2/20
	2/93	Kit	4x QF2/18 + 6x QF2/20
	2/94	Kit	1x QF2/9 + 1x QF2/8
	2/1	Handle without blade	1x QF2/1 + 3x QF2/5B + 1x QF2/19 + 1x QF2/20 + 1x QF2/10 + 1x QF2/13 + 1x QF2/12 + 1x QF2/14 + 1x QF2/35

	2/2	Handle with anvil-blade	1x QF2/2 + 1x QF2/4 + 4x QF2/7 + 1x QF2/18 + 1x QF2/36
	2/35	Plastic coating for blade handle	1x QF2/35
	2/36	Coating for anvil-blade handle	1x QF2/36
	2/5B	Rivet for blade	1x QF2/5B
	2/7	Rivet for anvil-blade	1x QF2/7
	2/8	Bolt	1x QF2/8
	2/9	Nut	1x QF2/9
	2/10	Bush	1x QF2/10
	2/11	White spring	1x QF2/11
	2/12	Thumb catch	1x QF2/12
	2/13	Spring for thumb catch	1x QF2/13
	2/14	Screw for thumb catch	1x QF2/14
	2/15	Catch plate	1x QF2/15
	2/16	Locking segment	1x QF2/16
	2/17	Screw for locking segment	1x QF2/17
	2/18	Cushion	1x QF2/18
	2/19	Edging	1x QF2/19

## Maintenance



### Cleaning

It is advisable to clean your tool after each use.

If your tool is particularly dirty or subject to rusting after exposure to moisture, do not delay cleaning.



### Oiling

After cleaning, it is advisable to oil the tool so as to protect it from corrosion. The oil will also unjam the tool.



### Sharpening

It is advisable to sharpen your tool at least once a day, but if you feel that your tool is not cutting as well as usual, sharpen it right away!



### Dismantling

It is advisable to dismantle your tool on a regular basis, but at the very latest when it appears to be jammed.

---

## Replacement parts



### Changing the blade

When the blade and the anvil-blade no longer cross, or when the blade is badly damaged, it is advisable to change it.

Regulate the working of the blade and anvil-blade by adjusting the tightening of the nut. The blade should rub against the anvil-blade over 2/3 of its length.



### Changing the shock absorber

When the tool closes too abruptly during pruning, and the cushion is in good condition, the shock absorber should be changed.



### Changing the cushion

When the tool closes too abruptly during pruning and the shock absorber is in good condition, the cushion must be changed.



### Changing the thumb catch

When the thumb catch is damaged and loosens when used, even when the screw is readjusted, change it.



### Changing the plastic coatings for handles

If the coatings are badly damaged, you can replace them.

Soak the coatings for 2 minutes in boiling water - recommended glue: Loctite 415.

---