

Zenport QF6 7.7 inch Classic Professional Pruner

Pruning shear - High performance - Ergonomic - Compact - Industry Standard Architecture



- **Reliable:** comfortable, light, sturdy handles made of forged aluminium with blade and screw-mounted anvil blade made of high-quality hardened steel / clean, precise cut / all parts can be replaced
- **Efficient:** easy, durable cutting adjustment / wire cutting notch / sap groove
- **Ergonomic:** hand and wrist protection are provided by the ideal shape of the handles and the cushion-shock absorber / non-slip coating

Our recommendation (1★: Recommended, 2★: Strongly recommended, 3★: Best fit)

Viticulture	★★★
Arboriculture	★★★
Horticulture	★★★
Parks and Gardens	★★★
Nursery	★★★
Small hand	★★★
Large hand	★★★
Left-handed	★★★

The points of excellence



Forged aluminium handles

Lightweight, strong and sturdy thanks to special aluminium alloys and advanced precision forging methods perfectly mastered by Zenport Industries.



Ergonomic tool

Inclined cutting head to reduce the risk of muscular-skeletal injuries and to maximise user comfort.

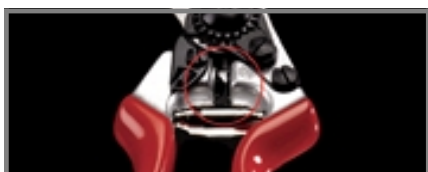

Shock absorption system

Zenport's special cushion stops reduce impact at the end of a cut, protecting hand and wrist.



Precision adjustment system

Zenport's micrometric adjustment system guarantees an optimal adjustment of the cutting head throughout the life of the tool, and delivers a clean and precise cut every time.



Sap groove

The sap groove prevents the blade sticking when cutting "sappy" wood. It saves time and makes pruning easier by removing sap and debris after each cut.









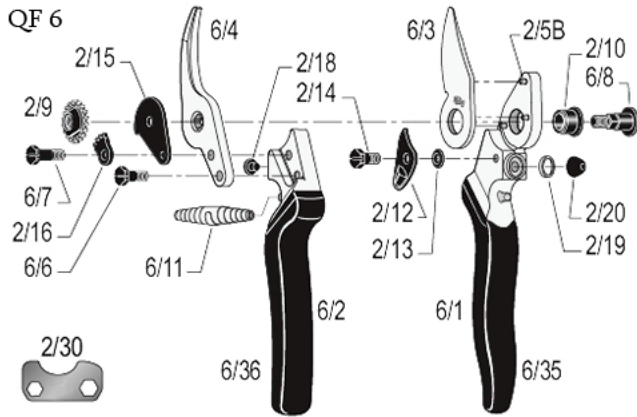



















Wire cutting notch

The blades of most QF series pruning shears feature a notch that allows for the cutting of small wires without damaging the cutting edge.

Spare parts



	REF.	Designation	Zenport Part Composition
	2/30	Adjustment key	1x QF2/30
	6/3	Blade	1x QF6/3
	6/4	Anvil-blade with screw	1x QF6/4 + 1x QF6/6
	6/90	Kit	1x QF6/7 + 1x QF2/16 + 1x QF2/9 + 1x QF6/8
	6/91	Kit	2x QF6/11
	2/92	Kit	1x QF2/15 + 1x QF2/18 + 1x QF2/14 + 1x QF2/12 + 1x QF2/13 + 1x QF2/20
	2/93	Kit	4x QF2/18 + 6x QF2/20
	6/94	Kit	1x QF2/9 + 1x QF6/8
	6/1	Handle without blade	1x QF6/1 + 3x QF2/5B + 1x QF2/19 + 1x QF2/20 + 1x QF2/10 + 1x QF2/13 + 1x QF2/12 + 1x QF2/14 + 1x QF6/35

	6/2	Handle without anvil-blade	1x QF6/2 + 1x QF2/18 + 1x QF6/36
	6/35	Plastic coating for blade handle	1x QF6/35
	6/36	Plastic coating for anvil-blade handle	1x QF6/36
	2/5B	Rivet for blade	1x QF2/5B
	6/6	Screw for anvil-blade	1x QF6/6
	6/8	Bolt	1x QF6/8
	2/9	Nut	1x QF2/9
	2/10	Bush	1x QF2/10
	6/11	White spring	1x QF6/11
	2/12	Thumb catch	1x QF2/12
	2/13	Spring for thumb catch	1x QF2/13
	2/14	Screw for thumb catch	1x QF2/14
	2/15	Catch plate	1x QF2/15
	2/16	Locking segment	1x QF2/16
	6/7	Screw for locking segment	1x QF6/7
	2/18	Cushion	1x QF2/18
	2/19	Edging	1x QF2/19

Maintenance



Cleaning

It is advisable to clean your tool after each use.

If your tool is particularly dirty or subject to rusting after exposure to moisture, do not delay cleaning.



Oiling

After cleaning, it is advisable to oil the tool so as to protect it from corrosion. The oil will also unjam the tool.



Sharpening

It is advisable to sharpen your tool at least once a day, but if you feel that your tool is not cutting as well as usual, sharpen it right away!



Dismantling

It is advisable to dismantle your tool on a regular basis, but at the very latest when it appears to be jammed.

Replacement parts



Changing the blade

When the blade and the anvil-blade no longer cross, or when the blade is badly damaged, it is advisable to change it.

Regulate the working of the blade and anvil-blade by adjusting the tightening of the nut. The blade should rub against the anvil-blade over 2/3 of its length.



Changing the anvil-blade

When the blade and anvil-blade no longer cross and the anvil-blade is badly damaged, it is advisable to change it.



Changing the shock absorber

When the tool closes too abruptly during pruning, and the cushion is in good condition, the shock absorber should be changed.



Changing the cushion

When the tool closes too abruptly during pruning and the shock absorber is in good condition, the cushion must be changed.



Changing the thumb catch

When the thumb catch is damaged and loosens when used, even when the screw is readjusted, change it.



Changing the plastic coatings for handles

If the coatings are badly damaged, you can replace them.

Soak the coatings for 2 minutes in boiling water - recommended glue: Loctite 415.
